

Svensk designtidning

Publiceringar gjorda 2024-07-01



Utfärdad av Patent- och registreringsverket Design- och varumärkesavdelningen

Box 530

826 27 SÖDERHAMN

Tel: 08-782 28 00

www.prv.se

kundsupport@prv.se

INNEHÅLLSFÖRTECKNING

Önskar du information om beslut kan du söka i Svensk Design databas

Nationella kungörelser

01 - Designregistreringar

1

01 - Designregistreringar

Registreringsnummer 85471 - 85473

Den som vill invända mot en registrering ska göra det inom två månader från kungörelsedagen (samma dag som registreringsdagen).

Invändningen skall innehålla:

Invändarens namn eller firma samt postadress.

Om invändaren är företrädd av ombud, ombudets namn och postadress.

Uppgift om de omständigheter som åberopas till grund för invändningen.

Invändningen ska vara undertecknad av invändaren eller dennes ombud.

Invändningen och andra handlingar som åberopas ska ges in i två exemplar.

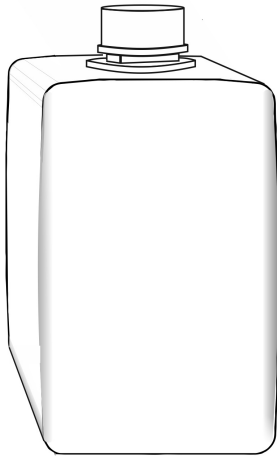
Ärendenummer:**2023-0240****Registreringsnummer:****85471**

1 - 1

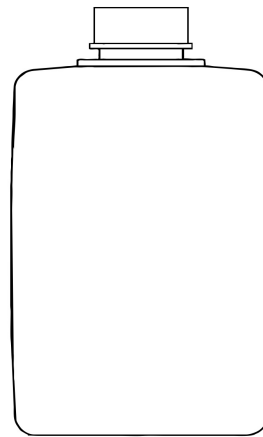

1 - 2

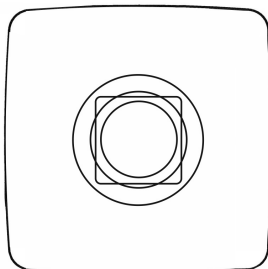

1 - 3

Produkt Nr 1: Refillflaska

Klasser (LOC 14): 09-01

Formgivare: Dennis Thorberg
Havsörnsvägen 21, 134 64 Ingarö, Sverige. (1)

Innehavare: Unique Cosmetics Sweden AB
Elektravägen 20, 12630 Hägersten, Sverige.

Ingivningsdag: 2023-12-29

Allmänt tillgänglig: 2024-06-30

Registrerad/kungjord: 2024-07-01

Giltig t.o.m.: 2028-12-29

Ärendenummer: 2024-0086
Registreringsnummer: 85472

Ställningsentreprenör:	
Tel:	
Ställningsbeställare:	
Tel:	
Färdigställd datum:	
Lastklasser enligt AFS	
L3 = 200 kg/m ²	
L4 = 300 kg/m ²	
L5 = 450 kg/m ²	
L6 = 600 kg/m ²	
Antal belastade bomlag:	st
Max belastning:	kg/ m ²
Kontrollerad oc godkänd av:	
Namnteckning	
	Monteringsanvisning kan laddas ner med QR koden
Det är förbjudet för obehöriga att ändra på eller att avlägsna skylten	
A-L TEKNIK AB	

1 - 1

Produkt Nr 1: Besiktnings-/kontrollkort
Klasser (LOC 14): 19-08
Formgivare: Tommy Löf
Norra Stallbacksvägen 31 , 425 43 Hisings Kärra, Sverige. (1)
Innehavare: A-L TEKNIK AB
Norra Stallbacksvägen 31 , 425 43 Hisings Kärra, Sverige.
Ingivningsdag: 2024-05-13
Registrerad/kungjord: 2024-07-01
Giltig t.o.m.: 2029-05-13

Ärendenummer:

2024-0090

Registreringsnummer:

85473



1 - 1

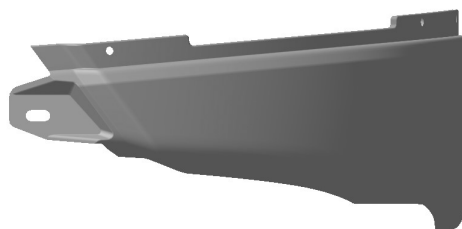

1 - 2



1 - 3

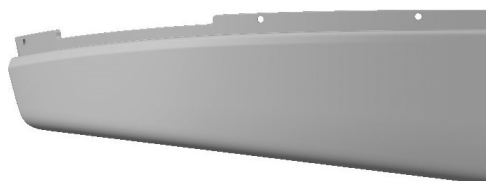

1 - 4

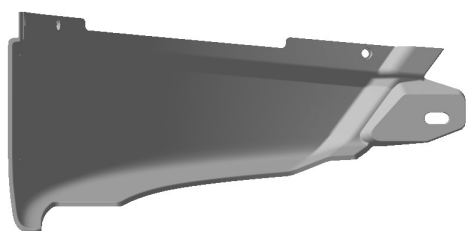

1 - 5

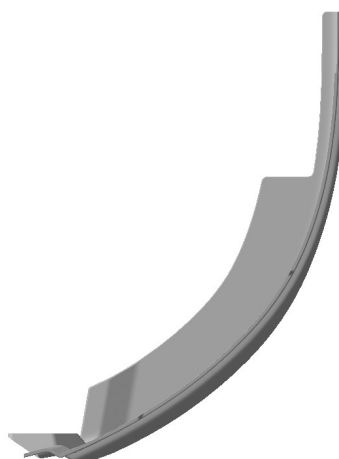

1 - 6

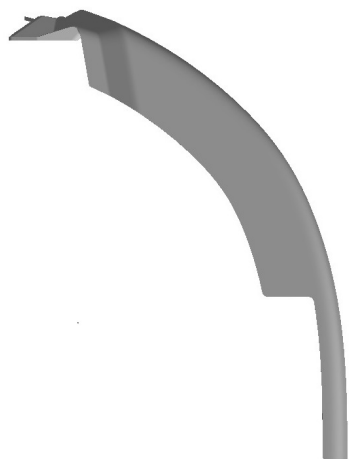

1 - 7

Produkt Nr 1: Panel för motorfordon
Klasser (LOC 14): 12-16
Formgivare: Dan Frykholm
Skärvallsgatan 9 , 426 79 Västra Frölunda, Sverige. (1)



2 - 1

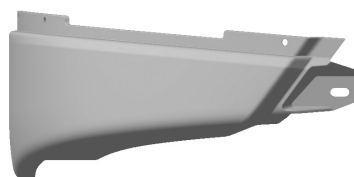

2 - 2

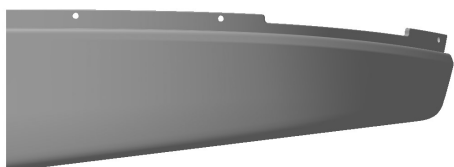

2 - 3



2 - 4

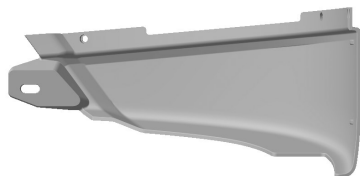

2 - 5

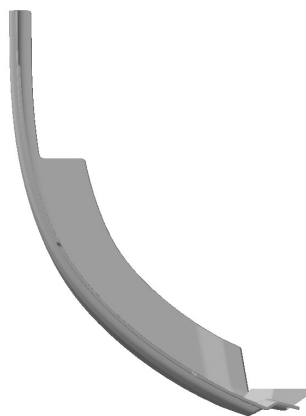

2 - 6

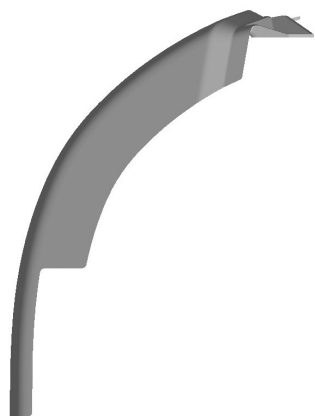

2 - 7

Produkt Nr 2: Panel för motorfordon
Klasser (LOC 14): 12-16
Formgivare: Dan Frykholm
Skärvallsgatan 9 , 426 79 Västra Frölunda, Sverige. (2)

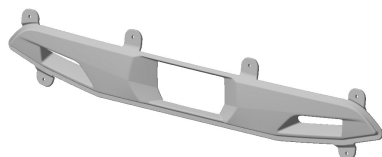

3 - 1



3 - 2



3 - 3



3 - 4



3 - 5



3 - 6



3 - 7

Produkt Nr 3: Panel för motorfordon
Klasser (LOC 14): 12-16
Formgivare: Dan Frykholm
Skärvallsgatan 9 , 426 79 Västra Frölunda, Sverige. (3)

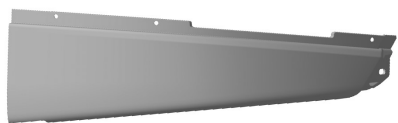

4 - 1

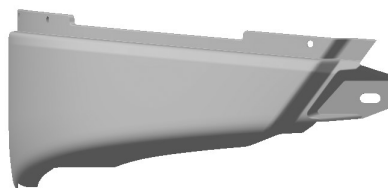

4 - 2



4 - 3



4 - 4

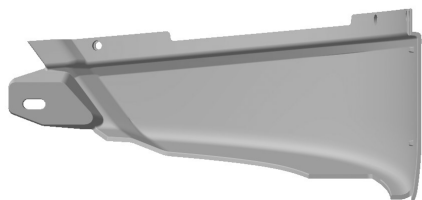

4 - 5

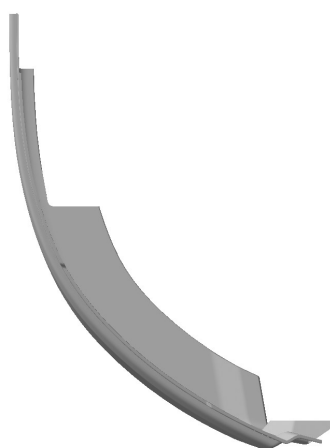

4 - 6

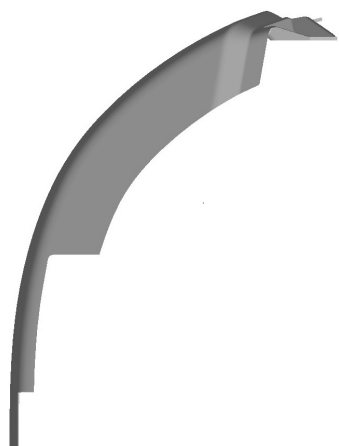

4 - 7

Produkt Nr 4: Panel för motorfordon
Klasser (LOC 14): 12-16
Formgivare: Dan Frykholm
Skärvallsgatan 9 , 426 79 Västra Frölunda, Sverige. (4)

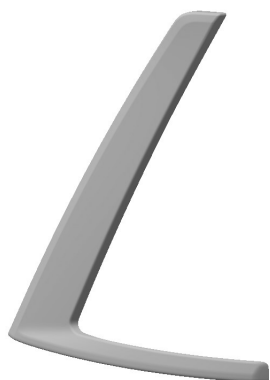

5 - 1

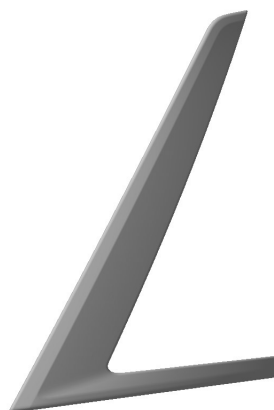

5 - 2

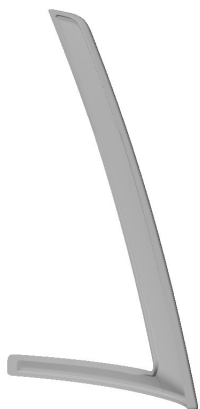

5 - 3

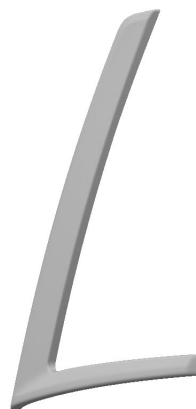

5 - 4

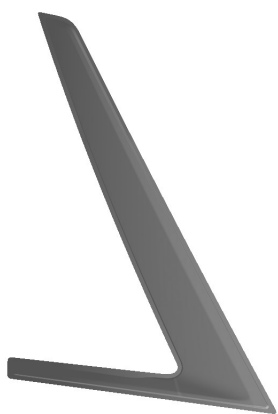

5 - 5



5 - 6



5 - 7

Produkt Nr 5: Panel för motorfordon
Klasser (LOC 14): 12-16
Formgivare: Dan Frykholm
Skärvallsgatan 9 , 426 79 Västra Frölunda, Sverige. (5)

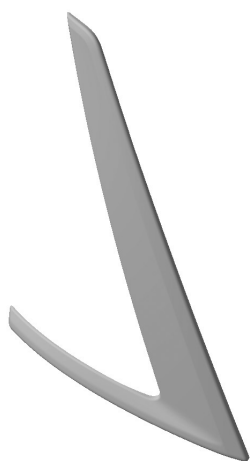

6 - 1

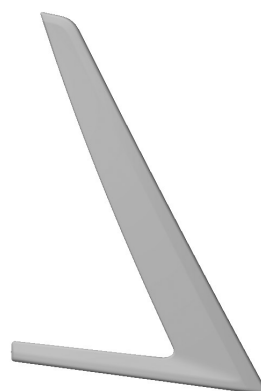

6 - 2

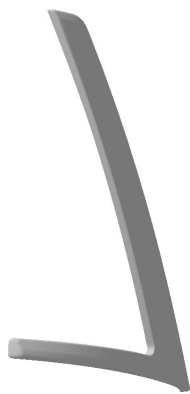

6 - 3

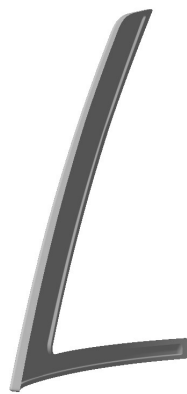

6 - 4

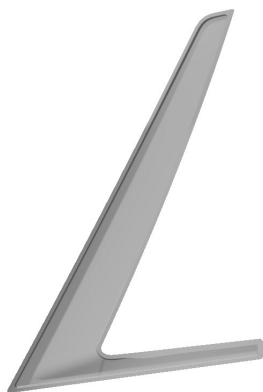

6 - 5



6 - 6



6 - 7

Produkt Nr 6: Panel för motorfordon
Klasser (LOC 14): 12-16
Formgivare: Dan Frykholm
Skärvallsgatan 9 , 426 79 Västra Frölunda, Sverige. (6)

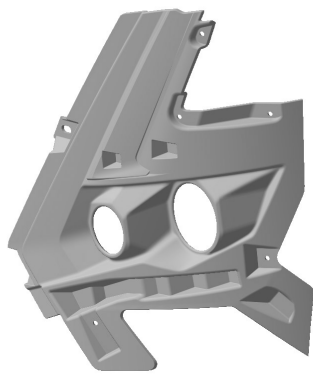

7 - 1

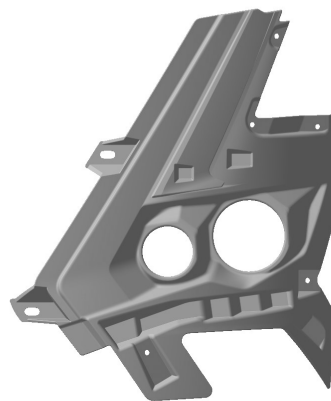

7 - 2



7 - 3



7 - 4

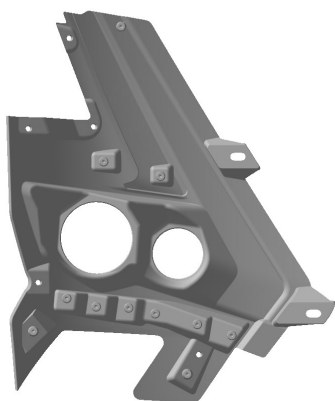

7 - 5

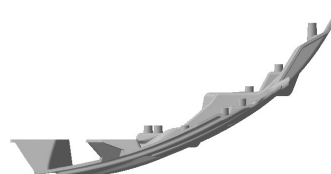

7 - 6

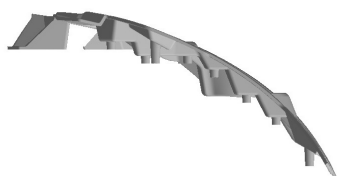

7 - 7

Produkt Nr 7: Strålkastarpanel för motorfordon
Klasser (LOC 14): 12-16
Formgivare: Dan Frykholm
Skärvallsgatan 9 , 426 79 Västra Frölunda, Sverige. (7)

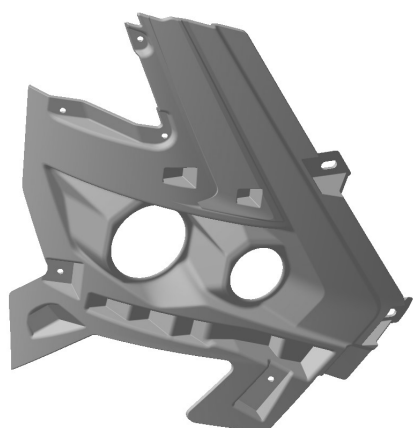

8 - 1

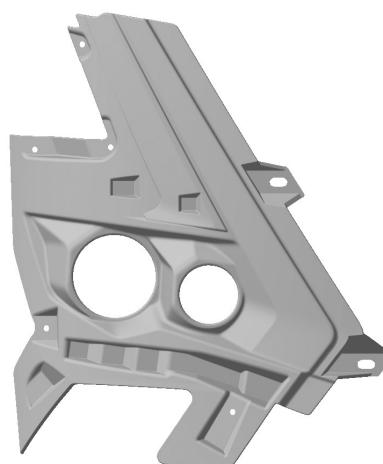

8 - 2

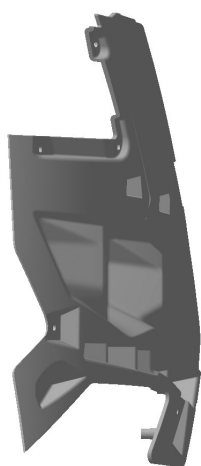

8 - 3



8 - 4

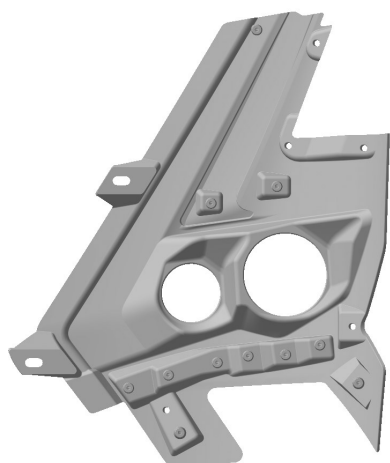

8 - 5

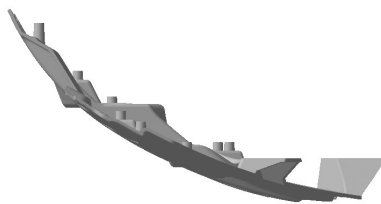

8 - 6



8 - 7

Produkt Nr 8: Strålkastarpanel för motorfordon
Klasser (LOC 14): 12-16
Formgivare: Dan Frykholm
Skärvallsgatan 9 , 426 79 Västra Frölunda, Sverige. (8)

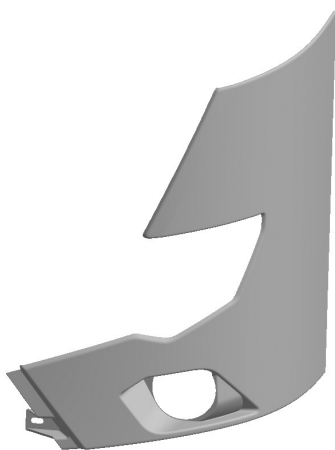

9 - 1

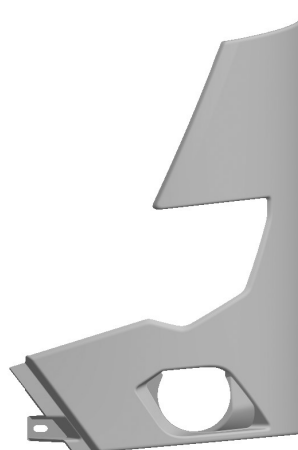

9 - 2

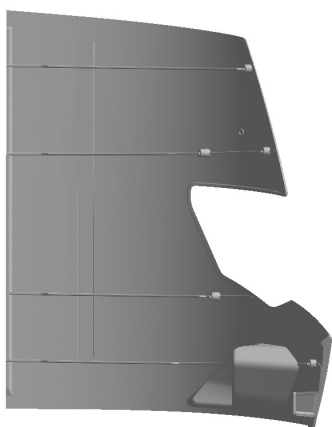

9 - 3

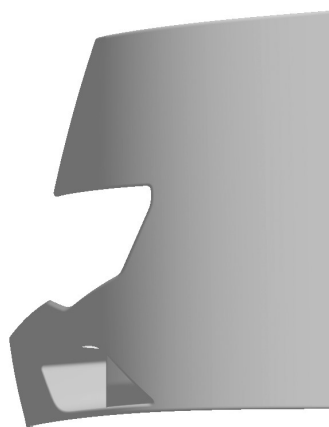

9 - 4

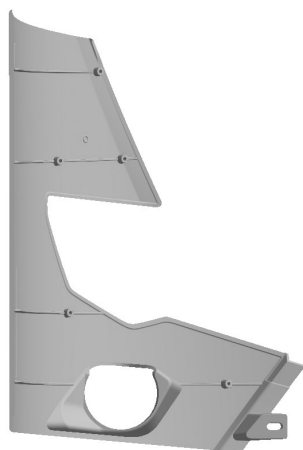

9 - 5

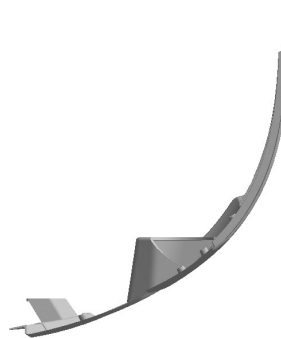

9 - 6



9 - 7

Produkt Nr 9: Panel för motorfordon
Klasser (LOC 14): 12-16
Formgivare: Dan Frykholm
Skärvallsgatan 9 , 426 79 Västra Frölunda, Sverige. (9)

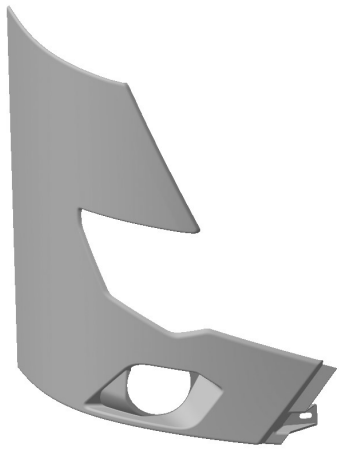

10 - 1

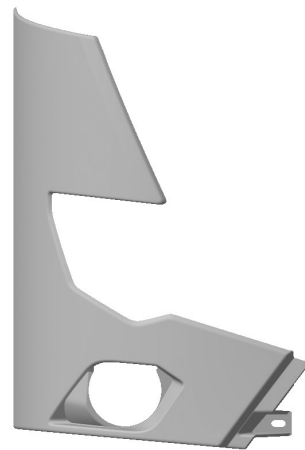

10 - 2

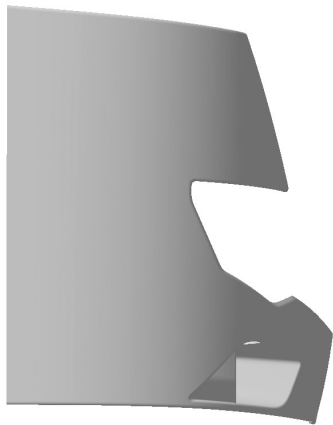

10 - 3

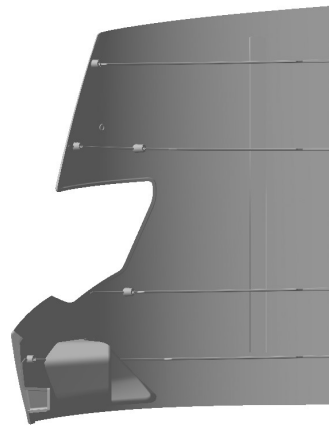

10 - 4

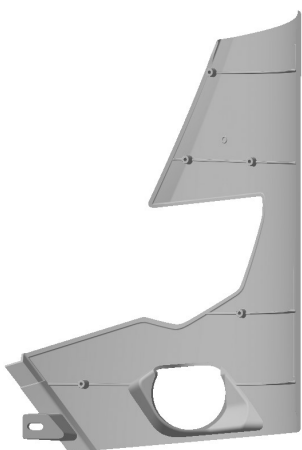

10 - 5

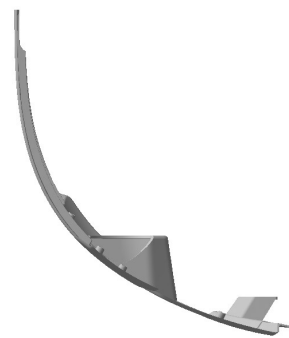

10 - 6



10 - 7

Produkt Nr 10: Panel för motorfordon
Klasser (LOC 14): 12-16
Formgivare: Dan Frykholm
Skärvallsgatan 9 , 426 79 Västra Frölunda, Sverige. (10)

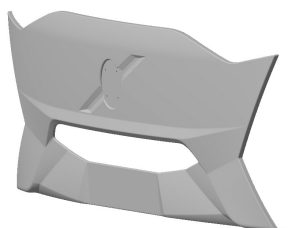

11 - 1

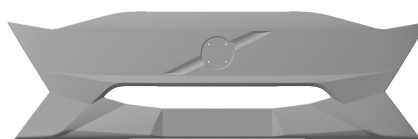

11 - 2



11 - 3



11 - 4

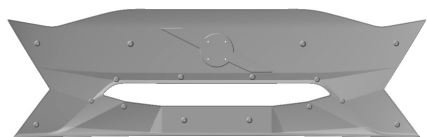

11 - 5



11 - 6



11 - 7

Produkt Nr 11: Frontpanel för motorfordon
Klasser (LOC 14): 12-16
Formgivare: Dan Frykholm
Skärvallsgatan 9 , 426 79 Västra Frölunda, Sverige. (11)

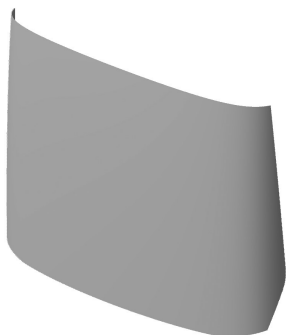

12 - 1



12 - 2



12 - 3



12 - 4



12 - 5



12 - 6



12 - 7

Produkt Nr 12: Vindruta till fordon
Klasser (LOC 14): 12-16
Formgivare: Dan Frykholm
Skärvallsgatan 9 , 426 79 Västra Frölunda, Sverige. (12)

Innehavare: Volvo Bus Corporation
., 405 08 Göteborg, Sverige.

Ombud: AWA Sweden AB
BOX 5117, 20071 Malmö, Sverige.

Ingivningsdag: 2024-05-14

Registrerad/kungjord: 2024-07-01

Giltig t.o.m.: 2029-05-14
